

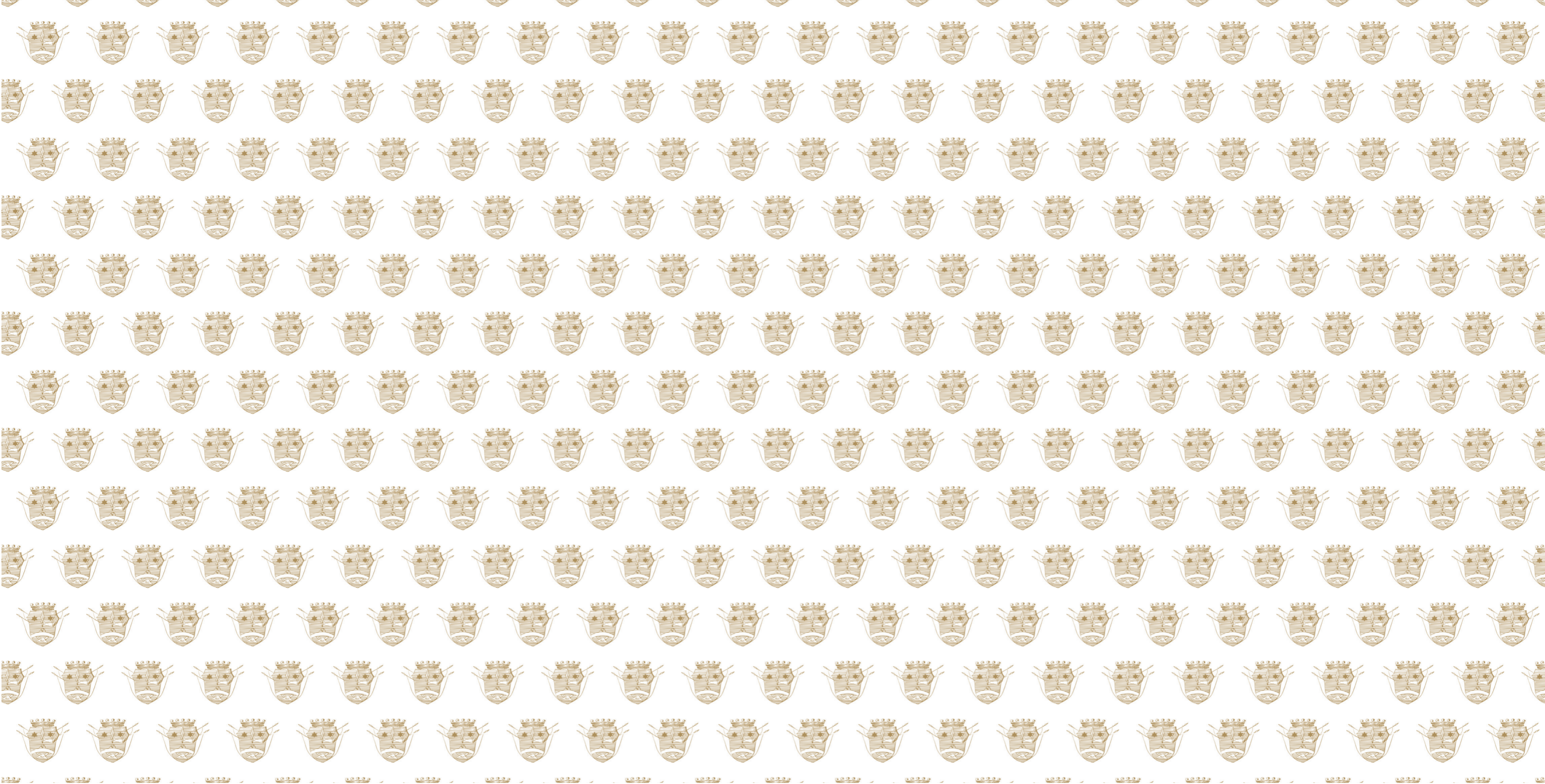

TRONF
made in italy



CATALOGO SATURNO | NETTUNO





DESIGN E FUNZIONALITA' SOTTO IL SOLE

Quando stile, praticità e comfort si incontrano in spiaggia, nascono NETTUNO e SATURNO: i tavolini da ombrellone firmati TRONA, pensati per rivoluzionare il modo di vivere le giornate al mare, con eleganza, ordine e funzionalità.

Progettati per rispondere alle esigenze di comfort moderno, questi tavolini trasformano ogni ombrellone in una vera e propria isola privata di benessere. Non solo semplici piani d'appoggio, ma veri e propri elementi di design funzionale che elevano l'esperienza balneare, offrendo comodità e praticità in ogni momento della giornata.

Che si tratti di una colazione all'aria aperta, di un pranzo leggero fronte mare o di un aperitivo al tramonto, i tavolini TRONA diventano il centro della scena: uno spazio comodo dove appoggiare piatti e bicchieri, leggere un libro, consultare il telefono, giocare a carte o semplicemente rilassarsi con tutto a portata di mano.

Entrambi i modelli si distinguono per l'alta qualità dei materiali e per l'inconfondibile tocco del design Made in Italy, capace di unire estetica, funzionalità e resistenza.

Con NETTUNO e SATURNO, la spiaggia si fa più bella, più comoda e più organizzata: il comfort sotto l'ombrellone non è mai stato così raffinato.

DESIGN AND FUNCTIONALITY UNDER THE SUN

When style, practicality, and comfort meet at the beach, NETTUNO and SATURNO are born: the beach umbrella tables by TRONA, designed to revolutionize the way we experience seaside days with elegance, order, and functionality.

Crafted to meet the needs of modern comfort, these tables transform every beach umbrella into a true private island of well-being. More than just surfaces to place your belongings, they are genuine pieces of functional design that elevate the beach experience, offering convenience and ease at any moment of the day.

Whether it's an open-air breakfast, a light lunch by the sea, or a sunset aperitif, TRONA tables take center stage: a practical space to place plates and glasses, read a book, check your phone, play cards, or simply relax with everything within reach.

Both models stand out for the high quality of materials and the unmistakable touch of Made in Italy design, perfectly blending aesthetics, functionality, and durability.

With NETTUNO and SATURNO, the beach becomes more beautiful, more comfortable, and better organized: comfort under the umbrella has never been so refined.



TAVOLINO NETTUNO \ NETTUNO TABLE

TAVOLINO NETTUNO

Il tavolino ampio e multifunzionale per l'ombrellone

NETTUNO è il tavolino da spiaggia ideale per chi cerca praticità e solidità senza rinunciare allo stile.

La sua struttura ampia e robusta consente di creare una vera e propria superficie d'appoggio sotto l'ombrellone, perfetta per colazioni, pranzi veloci, aperitivi, letture, giochi da tavolo e momenti di svago.

Grazie al sistema di fissaggio semplice e sicuro, NETTUNO si installa facilmente sul palo dell'ombrellone, offrendo stabilità anche in presenza di vento o movimento.

La sua ampiezza lo rende ideale anche per le famiglie, che possono così organizzare al meglio lo spazio sotto l'ombrellone, mantenendo ordine e comfort.

Realizzato con materiali resistenti e adatti all'ambiente balneare, NETTUNO è pensato per durare nel tempo e affrontare senza problemi sole, sabbia e salsedine. Un complemento indispensabile per stabilimenti balneari che vogliono offrire un servizio premium ai propri clienti.

NETTUNO TABLE

The spacious and multifunctional beach umbrella table

NETTUNO is the ideal beach table for those seeking practicality and sturdiness without compromising on style. Its wide and solid structure creates a true support surface under the umbrella—perfect for breakfasts, quick lunches, aperitifs, reading, board games, and moments of relaxation.

Thanks to its simple and secure fastening system, NETTUNO can be easily attached to the umbrella pole, ensuring excellent stability even in windy conditions or with movement.

Its generous size makes it especially suitable for families, allowing for a well-organized space under the umbrella while maintaining comfort and order.

Crafted from durable materials specifically designed for beach environments, NETTUNO is built to withstand sun, sand, and salt over time. An essential accessory for beach resorts looking to offer their clients a premium, high-comfort service.



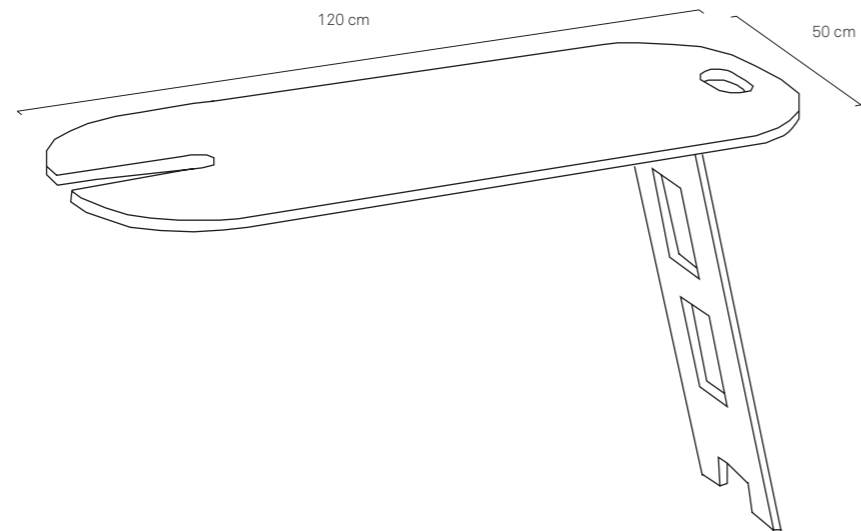

SPECIFICHE TECNICHE TECHNICAL SHEET

> Dimensioni: cm 120x50

> Codice: TAV-NTN-13

> Materiale: Okumé Marino e piano
in plexiglas bianco accoppiato

> Colore: Bianco

> Dimensions: cm 120x50

> Code: TAV-NTN-13

> Material: Marine-grade Okumé
wood with white laminated
plexiglass top

> Color: White



Design pratico e maneggevole
Practical and easy-to-handle design



Piano in plexiglass
Top in plexiglass

Facilmente pulibile e lavabile
Easy to clean and wash

Struttura in okumé marino
Structure in marine okumé

leggero e resistente
lightweight and durable





INSTALLAZIONE E COMPATIBILITÀ

Il tavolino NETTUNO è progettato per essere facilmente installato sul palo dell'ombrellone, utilizzando come supporto il piattello di fissaggio solitamente già integrato nella maggior parte delle strutture balneari.

Qualora il cliente non disponesse di questo elemento, TRONA può fornire un apposito piattello compatibile, identico a quello mostrato nella foto, disponibile su richiesta con un costo aggiuntivo.

In questo modo, sarà possibile garantire la massima stabilità del tavolino e un'esperienza d'uso ottimale, in totale sicurezza e praticità.

INSTALLATION AND COMPATIBILITY

The NETTUNO table is designed to be easily installed on the umbrella pole, using the fixing plate that is typically already integrated into most beach resort setups.

If the customer does not have this component, TRONA can provide a compatible plate—identical to the one shown in the photo—available upon request for an additional cost.

This ensures maximum table stability and an optimal user experience, with complete safety and convenience.





MODULARITÀ INTELLIGENTE

Per una superficie ancora più ampia, è possibile unire due tavolini NETTUNO, creando così un piano d'appoggio continuo, ideale per pranzi in compagnia, giochi da tavolo o momenti di condivisione sotto l'ombrello.

SMART MODULARITY

For an even larger surface area, two NETTUNO tables can be joined together, creating a continuous tabletop—perfect for shared meals, board games, or moments of togetherness under the umbrella.



TAVOLINO SATURNO \ SATURNO TABLE

TAVOLINO SATURNO | *Il tavolo-vassoio pratico e intelligente*

SATURNO è il tavolo-vassoio da ombrellone che unisce leggerezza, praticità e versatilità in un unico prodotto.

Realizzato in PVC e policarbonato, è resistente, facile da pulire e perfetto per un utilizzo intensivo in ambiente balneare.

La sua doppia funzione lo rende un alleato prezioso per ogni giornata in spiaggia: può essere utilizzato come vassoio portatile per ritirare cibi e bevande al bar, e una volta sotto l'ombrellone si trasforma in un comodo tavolino da installare con un semplice gesto.

SATURNO è anche un efficace strumento di comunicazione: al suo interno è possibile inserire il menù del bar, offerte del giorno, QR code per ordinazioni digitali o messaggi promozionali, offrendo così un valore aggiunto sia per il cliente che per il gestore dello stabilimento.

Compatto, maneggevole e dal design essenziale, SATURNO è la soluzione ideale per ottimizzare l'esperienza in spiaggia con intelligenza e stile.

SATURNO TABLE | *The Practical and Smart Tray-Table*

SATURNO is the umbrella tray-table that combines lightness, practicality, and versatility in a single product.

Made of PVC and polycarbonate, it is durable, easy to clean, and perfect for intensive use in beach environments.

Its dual function makes it a valuable ally for any day at the beach: it can be used as a portable tray to pick up food and drinks from the bar, and once under the umbrella, it transforms into a convenient table with a simple gesture.

SATURNO also serves as an effective communication tool: inside, you can insert the bar menu, daily specials, QR codes for digital ordering, or promotional messages—offering added value for both guests and beach operators.

Compact, easy to handle, and featuring a clean, minimalist design, SATURNO is the ideal solution to enhance the beach experience with intelligence and style.



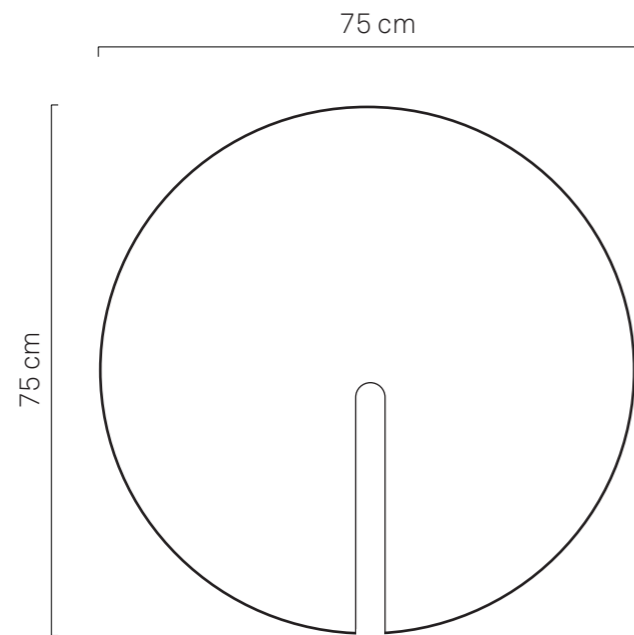

SPECIFICHE TECNICHE

- > Diametro Ø 75 cm
- > Codice: TAV-STR-13
- > Materiale: PVC e Policarbonato
- > Colore: Bianco
- > Stampa in quadricromia

TECHNICAL SHEET

- > Diameter Ø 75 cm
- > Code: TAV-STR-13
- > Material: PVC and Polycarbonate
- > Colour: white
- > Printing in four colours process

CARATTERISTICHE

- > Personalizzabile
- > Pratico
- > Lavabile
- > Resistente
- > Maneggevole

FEATURES

- > Customizable
- > Practical
- > Washable
- > Resistant
- > Easy to handle

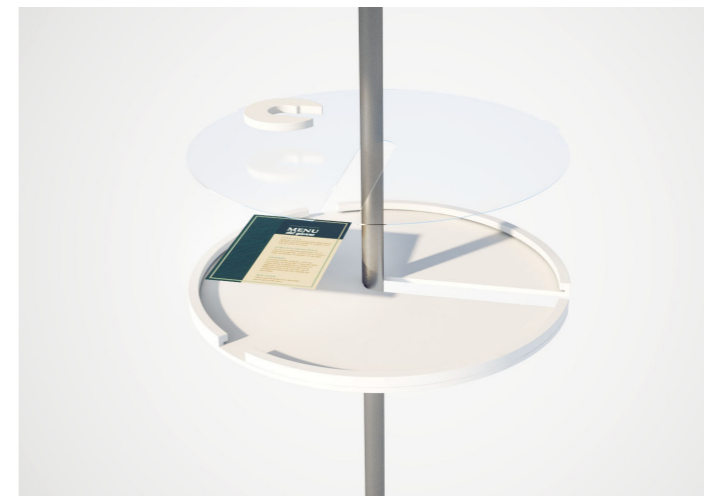

VANTAGGI

- Facile sistema di fissaggio: la pinza si fissa a pressione
- Lavabile e resistente: tutti i materiali utilizzati sono lavabili e il piano in policarbonato ne aumenta la protezione.
- Spazio per menù del giorno e comunicazioni speciali: tra i doppi strati di PVC e Policarbonato si possono inserire menù, flyer o altra comunicazione di servizio.
- Spazioso: permette di essere utilizzato in ogni occasione, dalla colazione all'aperitivo (diametro cm 75)
- Personalizzabile: è possibile stampare sulla superficie qualsiasi immagine o logo
- Pratico e maneggevole: si infila e sfila in modo semplice e veloce

BENEFITS

- Easy fastening system: the clamp attaches with a simple pressure mechanism.
- Washable and durable: all materials used are washable, and the polycarbonate top adds extra protection.
- Space for daily menus and special messages: menus, flyers, or other service communications can be inserted between the double layers of PVC and polycarbonate.
- Spacious: suitable for any occasion, from breakfast to aperitif (diameter: 75 cm).
- Customizable: any image or logo can be printed on the surface.
- Practical and easy to handle: it can be quickly and easily inserted and removed.



PROPOSTE GRAFICHE / GRAPHIC PROPOSALS

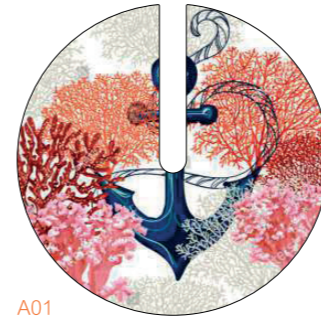

A01



A02

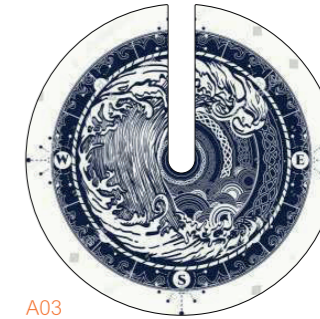

A03



A04

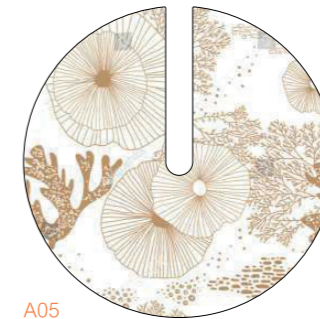

A05



A06

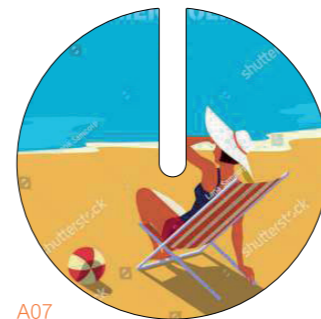

A07

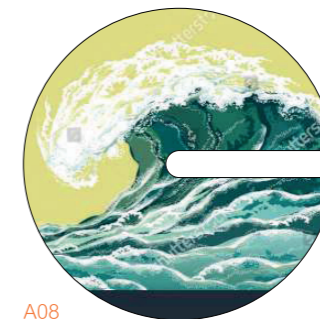

A08



A09



A10



A11

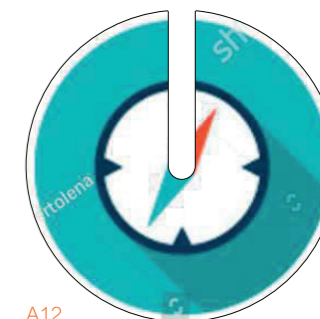

A12



A13

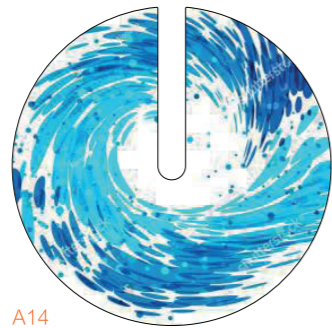

A14

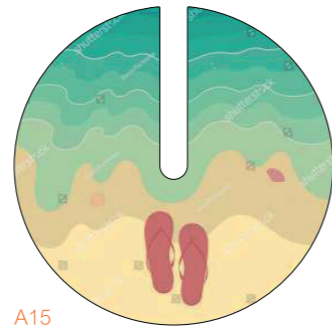

A15



A37

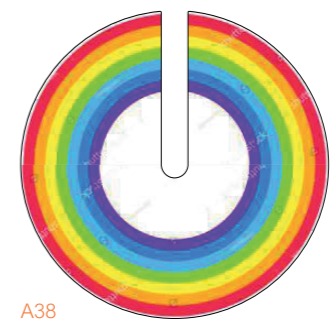

A38

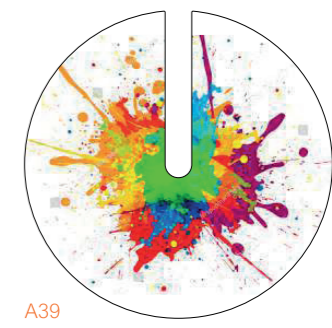

A39



A16



A17

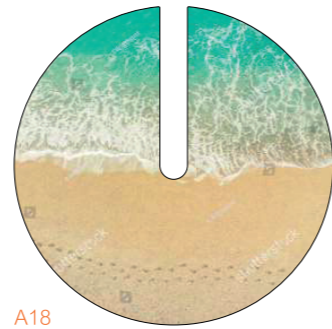

A18



A40



A41



A42

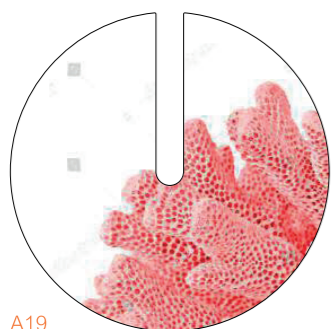

A19



A20



A21



A25

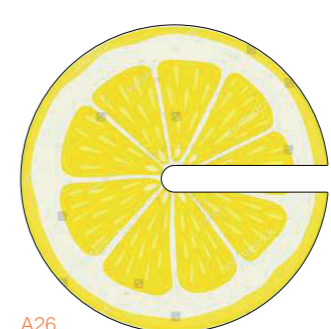

A26

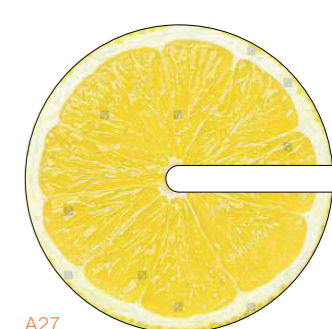

A27



A22

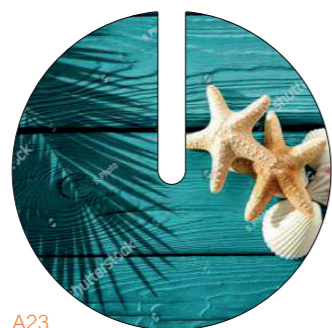

A23



A24



A28



A29

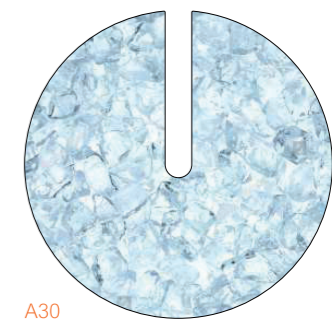

A30

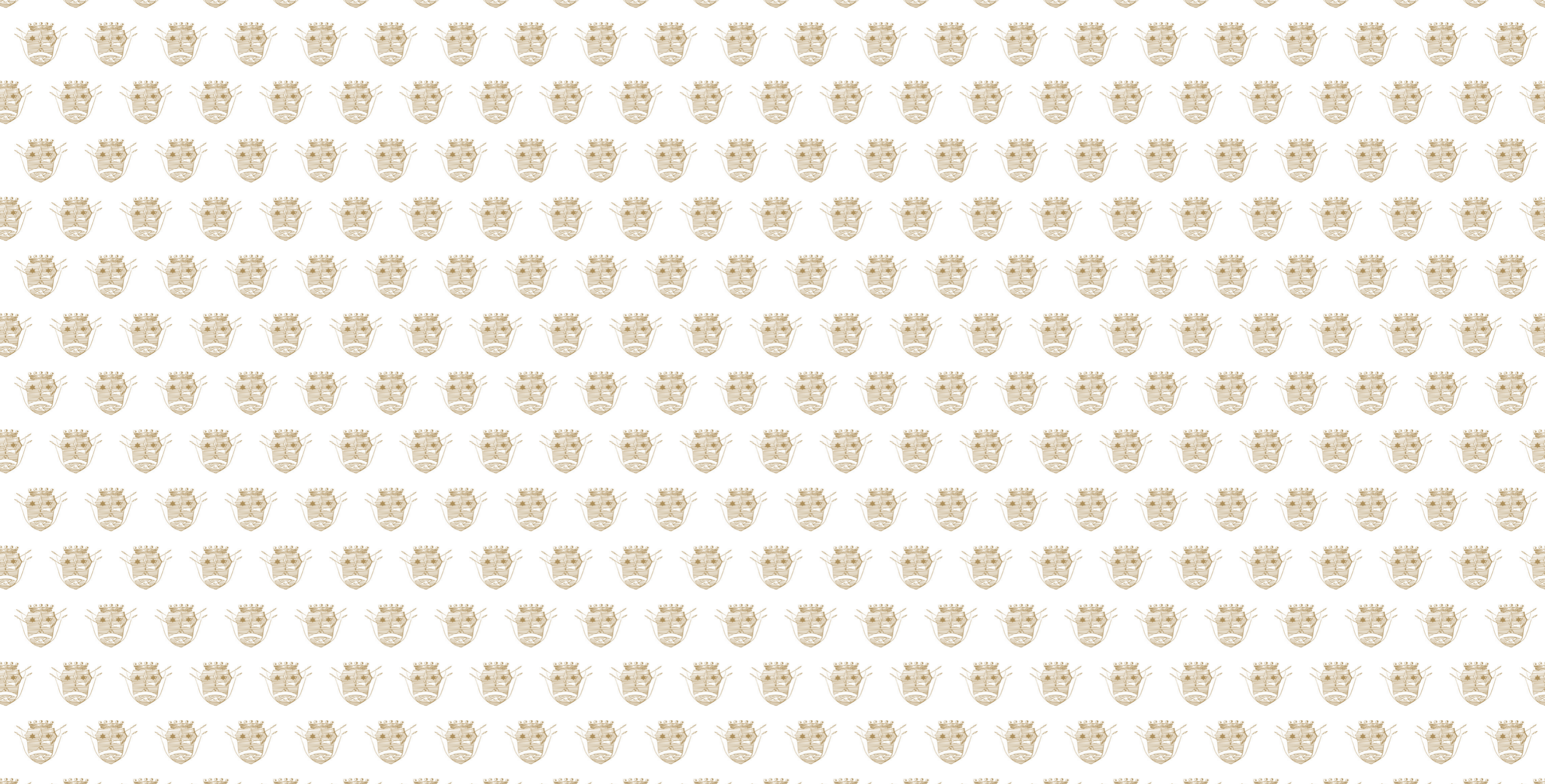



TRONA by BLUESTAR Fashion Design

Sede Legale: Via F. Tocchi Michelini, 18 - 61122 Pesaro (PU)
Stabilimento: Strada della Fabbrina 6/B - 61122 Pesaro (PU)

T. +39 0721 1704479

M. +39 348 155 6249

info@trona.it | www.trona.it | www.buytrona.com